



# SC20J120B

## 产品特性 ( Feature )

- 零反向恢复电流

No reverse recovery current

- 正温度系数

Positive temperature coefficient

- 不受温度影响的开关特性

Temperature independent switching behavior

- 低压降、高工作温度

Low forward voltage and high operating temperature

- 优异的浪涌电流能力

Excellent surge current capability

$V_{RRM}$	1200	V
$I_F, T_C \leq 137^\circ C$	20	A
$Q_C \text{ Typ}$	61	nC

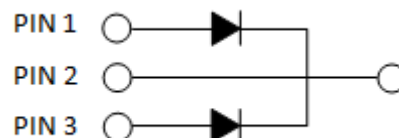

## 产品优点 ( Benefits )

- 降低电磁干扰

Reduce EMI

- 高功率密度，可用于更高的工作频率

High power density , enable higher frequency

- 降低散热要求，节约系统成本和尺寸

Reduce cooling requirements , save system cost and size

- 极大提升系统效率

Significantly improve system efficiency

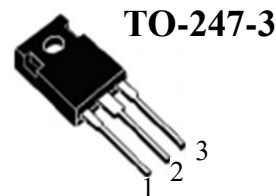

## 应用领域 ( Applications )

- 光伏逆变器

Solar inverters

- 功率因数校正

Power Factor Correction

- 不间断电源

Uninterruptable power supplies

- 电机驱动

Motor drives

## 订货型号 ( Order Message )

订货型号 Order codes		印记 Marking	封装 Package
有卤-条管 Halogen-Tube	无卤-条管 Halogen Free-Tube		
SC20J120B-GE-B	SC20J120B-GE-BR	SC20J120B	TO-247-3



## 额定值 Maximum ratings

Symbol	Parameter	Value	Unit	Test Conditions	Note
V <sub>RRM</sub>	反向重复峰值电压 Repetitive Peak Reverse Voltage	1200	V		
V <sub>RSM</sub>	反向浪涌峰值电压 Surge Peak Reverse Voltage	1200	V		
V <sub>DC</sub>	反向直流电压 DC Blocking Voltage	1200	V		
I <sub>F</sub>	正向平均电流 Continuous Forward Current	10 * 20 **	A	T <sub>C</sub> =150°C	
I <sub>FSM</sub>	正向非重复浪涌电流 Non-Repetitive Peak Forward Surge Current	80	A	T <sub>C</sub> =25°C, t <sub>p</sub> =10ms, Half Sine Wave	
T <sub>J</sub> , T <sub>stg</sub>	工作温度和存储温度 Operating Junction and Storage Temperature	-55 to +175	°C		

\*Per Leg, \*\* Per Device

## 电学特性 (单管芯) Electrical Characteristics, (Per Leg)

Symbol	Parameter	Typ.	Max.	Unit	Test Conditions	Note
V <sub>F</sub>	正向电压 Forward Voltage	1.45 2.2	1.7 3	V	I <sub>F</sub> = 10 A T <sub>J</sub> =25°C I <sub>F</sub> = 10 A T <sub>J</sub> =175°C	Fig. 1
I <sub>R</sub>	反向电流 Reverse Current	4 22	50 200	μA	V <sub>R</sub> = 1200 V T <sub>J</sub> =25°C V <sub>R</sub> = 1200 V T <sub>J</sub> =175°C	Fig. 2
Q <sub>C</sub>	总储存电荷 Total Capacitive Charge	61		nC	V <sub>R</sub> = 800V, T <sub>J</sub> = 25°C Q <sub>C</sub> = ∫ <sub>0</sub> <sup>V<sub>R</sub></sup> C(V)dV	Fig. 4
C	总电容 Total Capacitance	800 57 42		pF	V <sub>R</sub> = 0 V, T <sub>J</sub> = 25°C, f = 1 MHz V <sub>R</sub> = 400 V, T <sub>J</sub> = 25°C, f = 1 MHz V <sub>R</sub> = 800 V, T <sub>J</sub> = 25°C, f = 1 MHz	Fig. 3
E <sub>C</sub>	电容储存能量 Capacitance Stored Energy	15.6		μJ	V <sub>R</sub> = 600 V	Fig. 5

## 热性能(Thermal Characteristics)

Symbol	Parameter	Typ.	Unit	Note
R <sub>θJC</sub>	Thermal Resistance from Junction to Case	0.65	°C/W	Fig. 6



性能曲线图 Performance curve

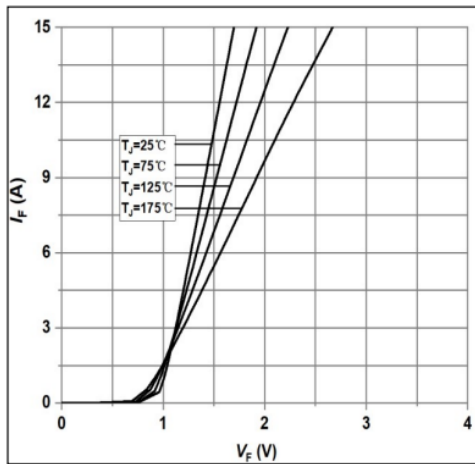

Figure 1. Forward Characteristics

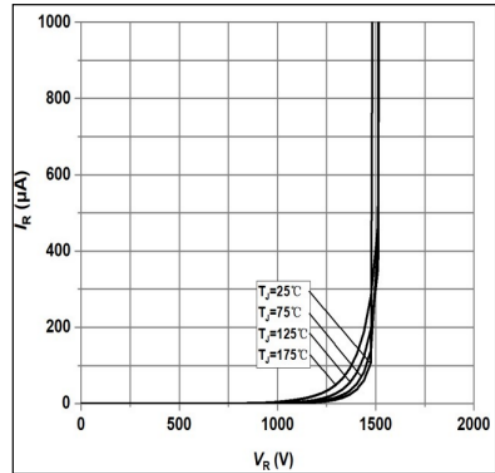

Figure 2. Reverse Characteristics

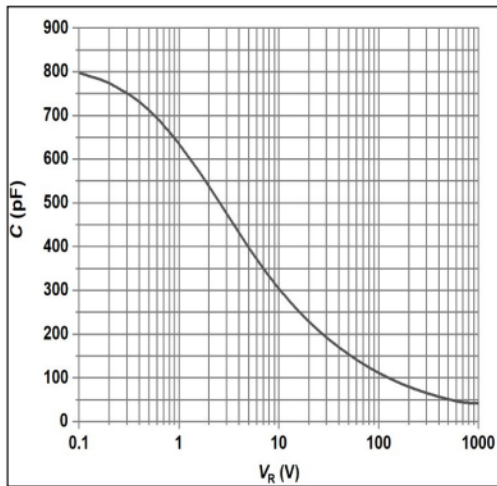

Figure 3. Capacitance vs. Reverse Voltage

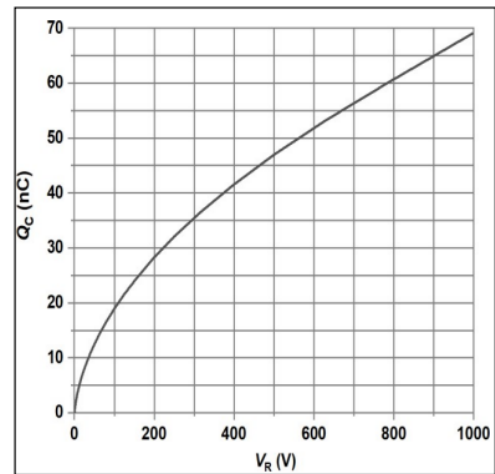

Figure 4. Capacitance Charge vs. Reverse Voltage

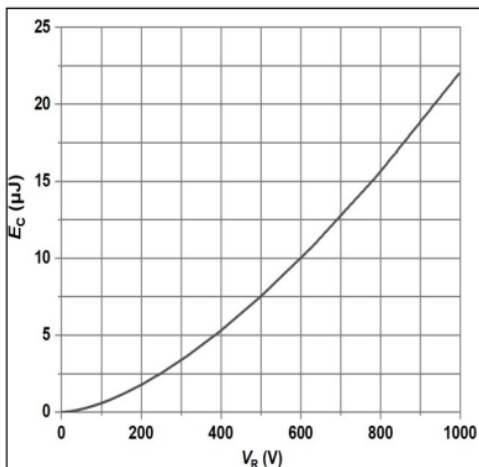

Figure 5. Capacitance Stored Energy

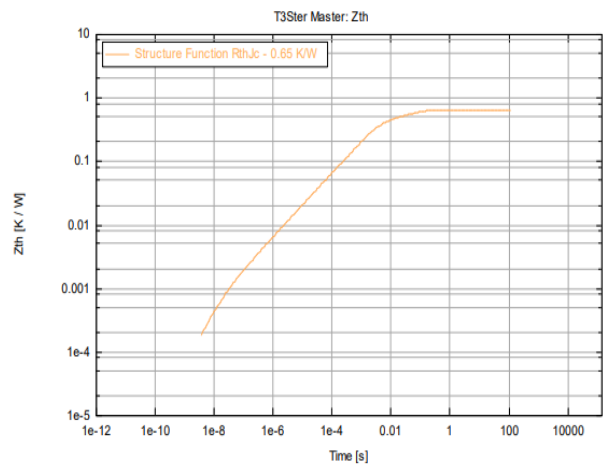
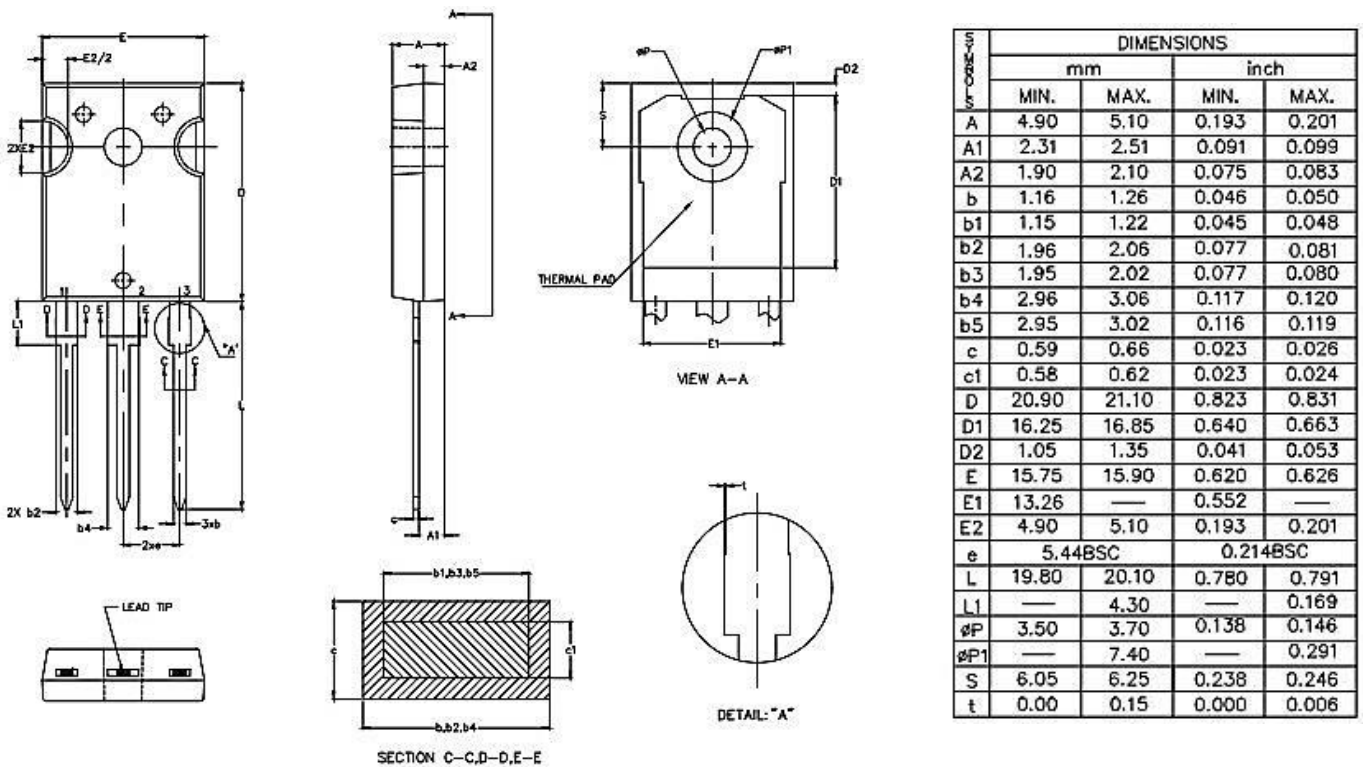

Figure 6. Transient Thermal Impedance



## Package Dimensions: TO-247-3



## 注意事项

1. 吉林华微电子股份有限公司的产品销售分为直销和销售代理，无论哪种方式，订货时请与公司核实。
2. 购买时请认清公司商标，如有疑问请与公司本部联系。
3. 在电路设计时请不要超过器件的绝对最大额定值，否则会影响整机的可靠性。
4. 本说明书如有版本变更不另外告知。

## NOTE

1. Jilin Sino-microelectronics co., Ltd sales its product either through direct sales or sales agent , thus, for customers, when ordering , please check with our company.
2. We strongly recommend customers check carefully on the trademark when buying our product, if there is any question, please don't be hesitate to contact us.
3. Please do not exceed the absolute maximum ratings of the device when circuit designing.
4. Jilin Sino-microelectronics co., Ltd reserves the right to make changes in this. specification sheet and is subject to change without prior notice.



**联系方式**

**吉林华微电子股份有限公司**

公司地址：吉林省吉林市深圳街 99 号

邮编：132013

总机：86-432-64678411

传真：86-432-64665812

网址：[www.hwdz.com.cn](http://www.hwdz.com.cn)

**CONTACT**

**JILIN SINO-MICROELECTRONICS CO., LTD.**

ADD: No.99 Shenzhen Street, Jilin City, Jilin Province, China.

Post Code: 132013

Tel: 86-432-64678411

Fax: 86-432-64665812

Web Site: [www.hwdz.com.cn](http://www.hwdz.com.cn)