



JT015N120WCD/ABCD

主要参数 MAIN CHARACTERISTICS

I _C	15 A
V _{CEs}	1200 V
V _{cesat_typ} (@V _{ge} =15V)	1.8V

用途

- 逆变器
- 电磁炉
- UPS 电源

APPLICATIONS

- General purpose inverters
- Induction heating(IH)
- UPS

产品特性

- 低栅极电荷
- FS 技术
- 通态压降, V_{CE(sat)}, typ = 1.8V @ I_C = 15A and T_C = 25°C
- RoHS 产品

FEATURES

- Low gate charge
- FS Technology
- saturation voltage: V_{CE(sat)}, typ = 1.8V @ I_C = 15A and T_C = 25°C
- RoHS product

封装 Package

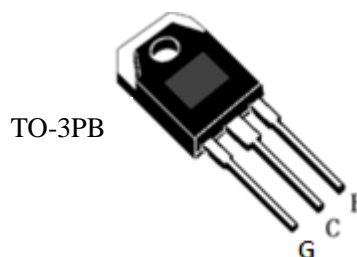
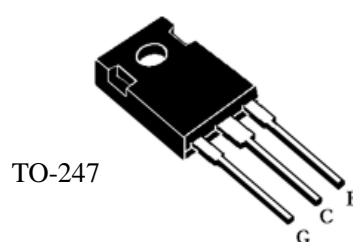
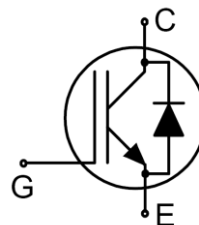

订货信息 ORDER MESSAGE

订货型号 Order codes	印记 Marking	封装 Package
有卤-条管 Halogen-Tube		
JT015N120WCD-GE-B	JT015N120WCD	TO-247
JT015N120ABCD-GD-B	JT015N120ABCD	TO-3PB





绝对最大额定值 ABSOLUTE RATINGS (Tc=25℃)

项 目 Parameter	符 号 Symbol	数 值 Value	单 位 Unit
		JT015N120WCD/ABCD	
最高集电极—发射极直流电压 Collector-Emmitter Voltage	V_{CES}	1200	V
连续集电极极电流 Collector Current-continuous	I_C T=25℃ T=100℃	30	A
		15	A
最大脉冲集电极极电流 (注 1) Collector Current – pulse (note 1)	I_{CM}	45	A
最高栅极发射极电压 Gate-Emmitter Voltage	V_{GES}	±20	V
安全工作区 Turn-off safe area	-	45	A
耗散功率 Power Dissipation	P_D T _C =25℃	200	W
最高结温及存储温度 Operating and Storage Temperature Range	T _J , T _{STG}	-55~+150	℃
引线最高焊接温度 Maximum Lead Temperature for Soldering Purposes	T _L	300	℃

*漏极电流由最高结温限制

*Collector current limited by maximum junction temperature





电特性 ELECTRICAL CHARACTERISTICS

项 目 Parameter	符 号 Symbol	测试条件 Tests conditions	最小 Min	典型 Typ	最大 Max	单 位 Units
关态特性 Off –Characteristics						
集电极—发射极击穿电压 Collector-Emmitter Voltage	BV_{CES}	$I_C=500\mu A, V_{GE}=0V$	1200	-	-	V
击穿电压温度特性 Breakdown Voltage Temperature Coefficient	$\Delta BV_{CES}/\Delta T_J$	$I_C=1mA$, referenced to $25^\circ C$	-	0.6	-	$V/^\circ C$
零栅压下集电极漏电流 Zero Gate Voltage Collector Current	I_{CES}	$V_{CE}=1200V, V_{GE}=0V,$ $T_C=25^\circ C$	-	-	0.2	mA
		$T_C=100^\circ C$	-	-	2	mA
		$T_C=150^\circ C$	-	-	2.5	mA
正向栅极体漏电流 Gate-body leakage current, forward	I_{GESF}	$V_{CE}=0V, V_{GE}=20V$	-	-	100	nA
反向栅极体漏电流 Gate-body leakage current, reverse	I_{GESR}	$V_{CE}=0V, V_{GE}=-20V$	-	-	-100	nA
通态特性 On-Characteristics						
阈值电压 Gate Threshold Voltage	$V_{GE(th)}$	$V_{CE} = V_{GE}, I_C=600\mu A$	4.5	-	6.5	V
饱和压降 Collector-Emmitter saturation Voltage	V_{CESAT}	$V_{GE}=15V, I_C=15A$ $T_C=25^\circ C$	-	1.8	2.4	V
		$T_C=125^\circ C$	-	2.0	-	
		$T_C=150^\circ C$	-	2.1	-	
短路电流（注2） Short Collector current（Note 2）	$I_{C(SC)}$	$V_{GE}=15V, V_{CE}=600V, t_{SC} < 10\mu s, T_C=25^\circ C$	-	120	-	A
动态特性 Dynamic Characteristics						
输入电容 Input capacitance	C_{ies}	$V_{CE}=25V,$ $V_{GE}=0V,$ $f=1.0MHz$	-	1330	2000	pF
输出电容 Output capacitance	C_{oes}		-	100	160	pF
反向传输电容 Reverse transfer capacitance	C_{res}		-	70	110	pF





电特性 ELECTRICAL CHARACTERISTICS

项 目 Parameter	符 号 Symbol	测试条件 Tests conditions	最小 Min	典型 Typ	最大 Max	单 位 Units	
开关特性 Switching Characteristics							
开启延迟时间 Turn-On delay time	$t_{d(on)}$	$V_{CE}=600V, I_C=15A, R_G=10\Omega$ $T_C=25^\circ C$ Inductive Load	-	80		ns	
上升时间 Turn-On rise time	t_r		-	65		ns	
关断延迟时间 Turn-Off delay time	$t_{d(off)}$		-	180		ns	
下降时间 Turn-Off Fall time	t_f		-	80		ns	
开启损耗 Turn-on energy	E_{on}				2.0		mJ
关断损耗 Turn-off energy	E_{off}				0.9		mJ
总的开关损耗 Total switching energy	E_{total}				2.9		mJ
栅极电荷总量 Total Gate Charge	Q_g	$V_{CE} = 600V,$ $I_C = 15A$ $V_{GE} = 15V$ (note 3, 4)	-	100		nC	
反并联二极管特性及最大额定值 Anti-Parallel Diode Characteristics and Maximum Ratings							
正向压降 Drain-Source Diode Forward Voltage	V_F	$V_{GE}=0V, I_F=15A$	-	1.6	2.9	V	
反向恢复时间 Diode Reverse recovery time	t_{rr}	$V_{GE}=0V, V_R=800V I_F=15A$ $di_F/dt=750A/\mu s$ (note 4)	-	200	-	ns	
反向恢复电荷 Reverse recovery charge	Q_{rr}		-	1.1	-	μC	

热特性 THERMAL CHARACTERISTIC

项 目 Parameter	符 号 Symbol	最大 Max	单 位 Unit
结到管壳的热阻 Thermal Resistance, Junction to Case	$R_{th(j-c)}$	0.6	$^\circ C/W$
结到环境的热阻 Thermal Resistance, Junction to Ambient	$R_{th(j-A)}$	40	$^\circ C/W$

注释:

- 1: 脉冲宽度由最高结温限制
- 2: 两次短路之间的间隔大于 1 秒时, 允许短路测试的次数最大为 1000 次
- 3: 脉冲测试: 脉冲宽度 $\leq 300\mu s$, 占空比 $\leq 2\%$
- 4: 基本与工作温度无关

Notes:

- 1: Pulse width limited by maximum junction temperature
- 2: Allowed number of short circuits: <1000; time between short circuits: >1s.
- 3: Pulse Test: Pulse Width $\leq 300\mu s$, Duty Cycle $\leq 2\%$
- 4: Essentially independent of operating temperature





特征曲线 ELECTRICAL CHARACTERISTICS (curves)

Typical Output Characteristics($T_j=25^\circ\text{C}$)

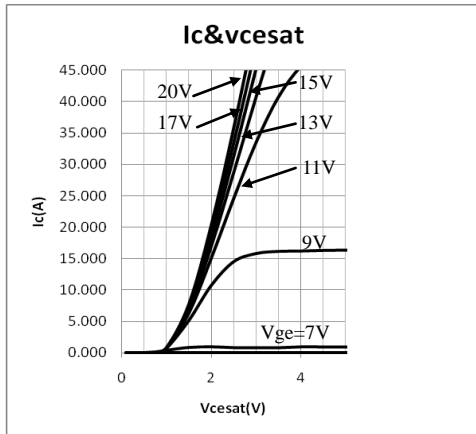

Typical Output Characteristics($T_j=150^\circ\text{C}$)

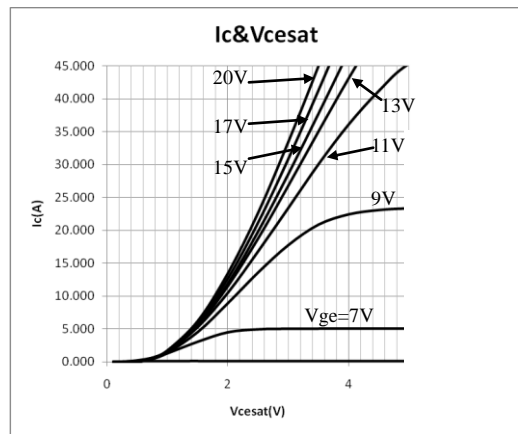

Typical Saturation Voltage Characteristics

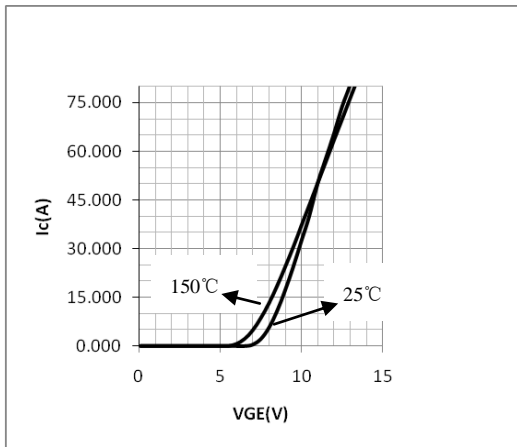

Saturation Voltage vs. Case Temperature at Variant Current Level

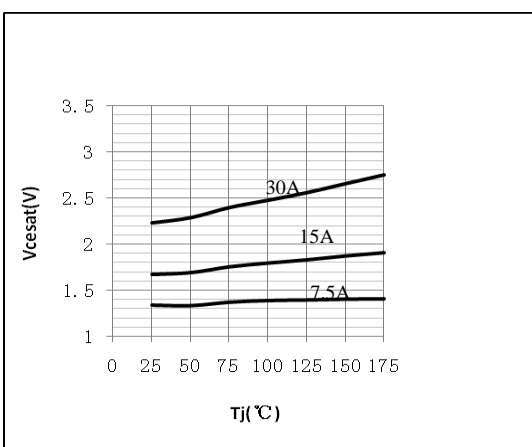

Capacitance Characteristics

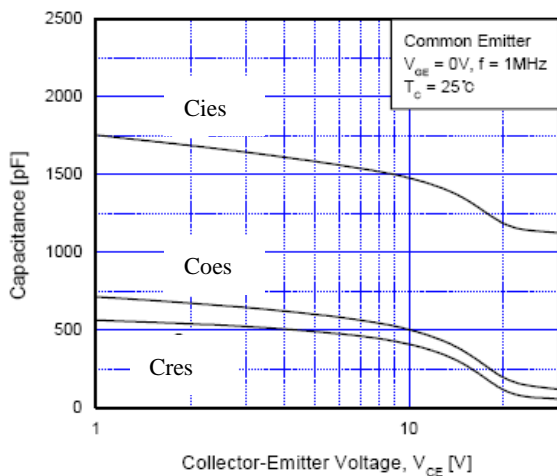

Turn-On Characteristics vs. Gate Resistance

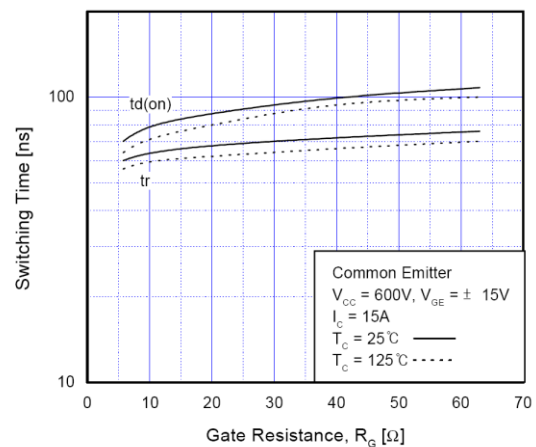



Turn-Off Characteristics vs. Gate Resistance

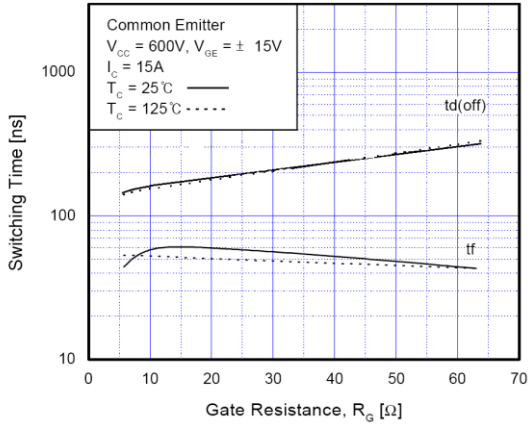

Switching Loss vs. Gate Resistance

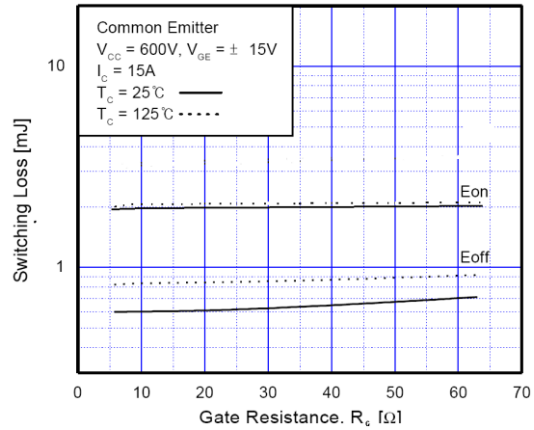

Turn-On Characteristics vs. Collector Current

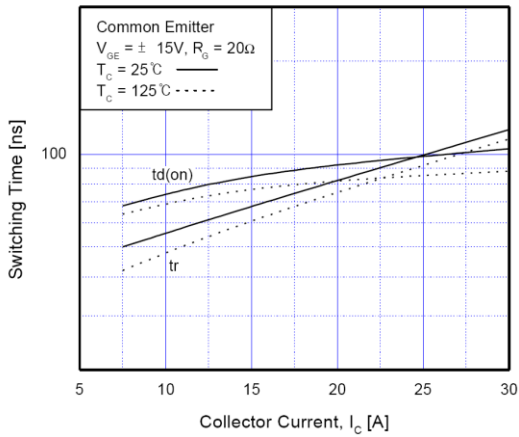

Turn-Off Characteristics vs. Collector Current

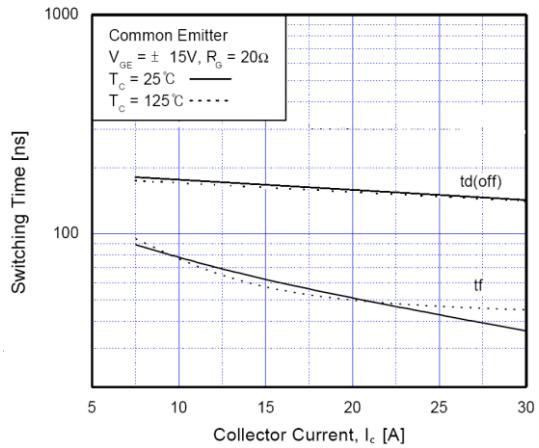

Switching Loss vs. Collector Current

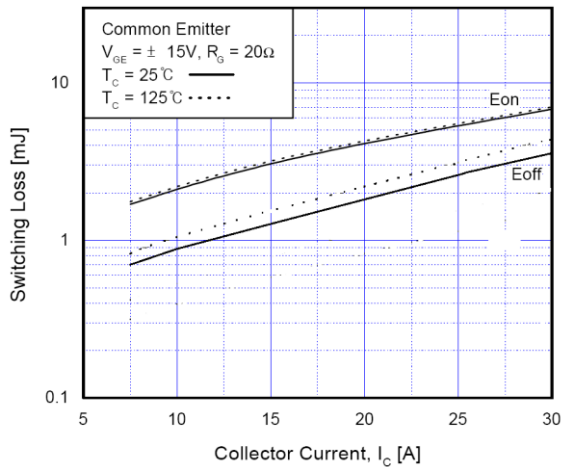

Gate Charge Characteristics

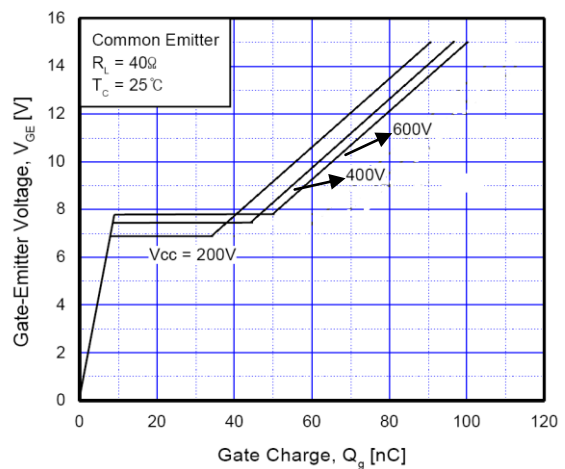



SOA Characteristics

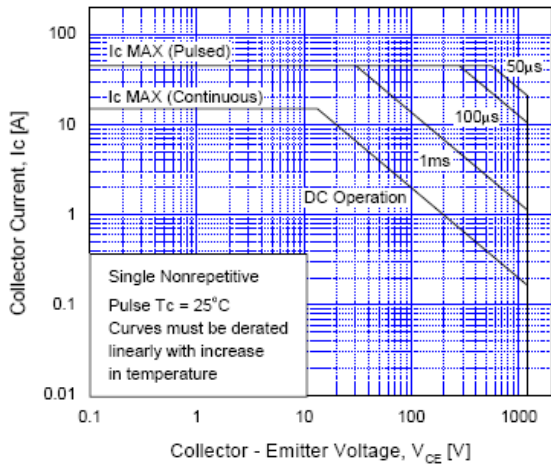

Turn-Off SOA

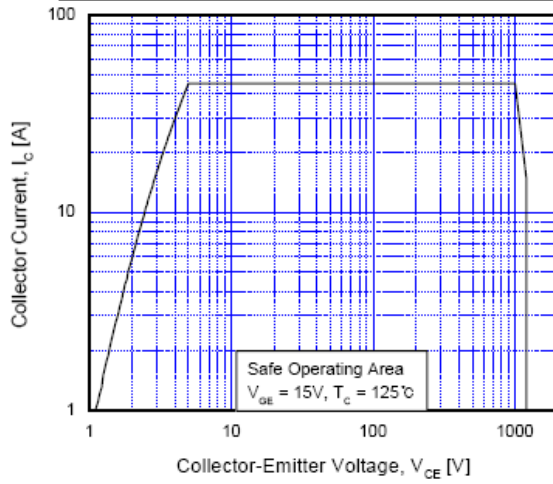

Transient Thermal Impedance

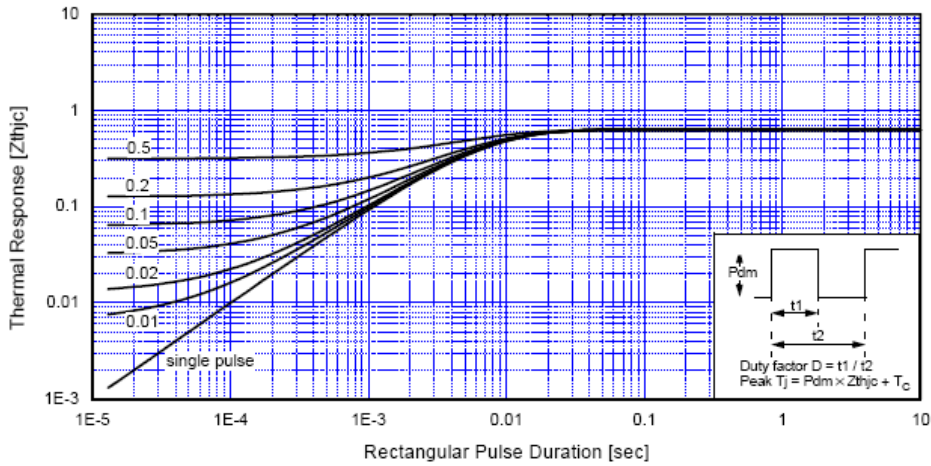

Forward Characteristics

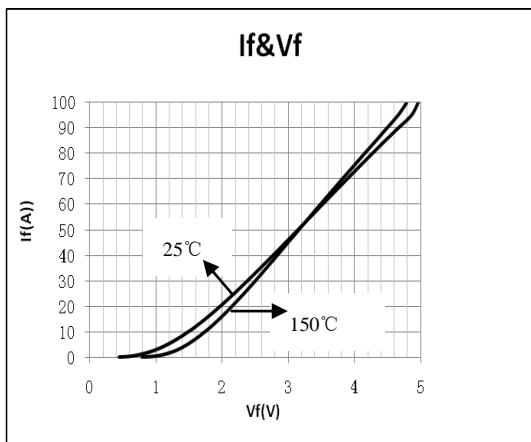

Reverse Recovery Current

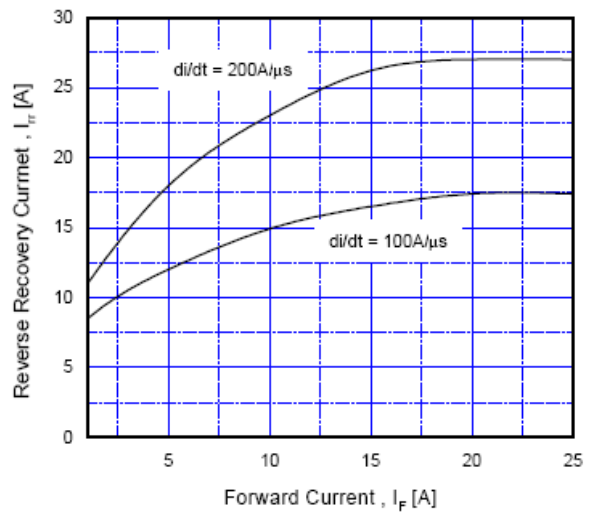



Stored Charge

Reverse Recovery Time

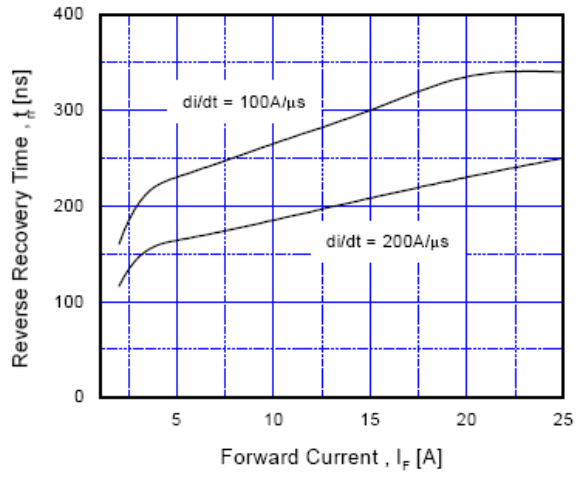
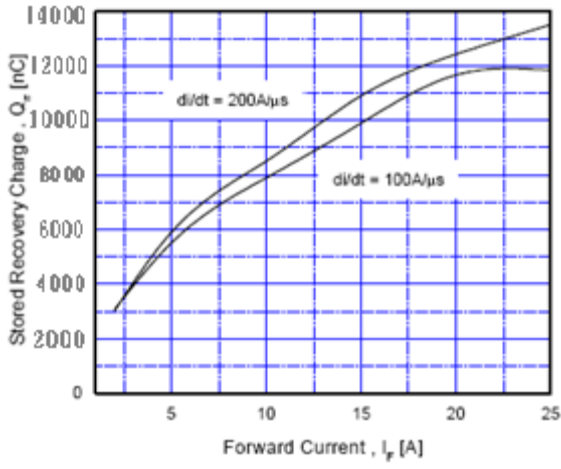



外形尺寸 PACKAGE MECHANICAL DATA

TO-247

单位 Unit: mm

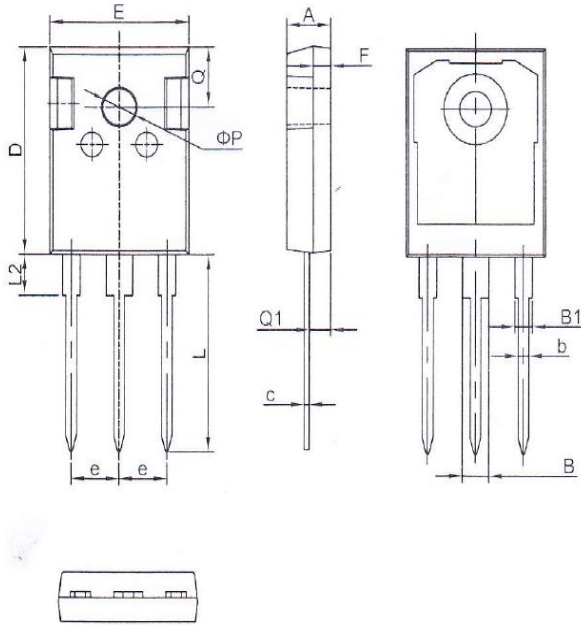

符号 symbol	MIN	MAX
A	4.90	5.10
B	2.95	3.35
B1	1.95	2.35
b	1.15	1.35
c	0.50	0.70
D	20.90	21.10
E	15.70	15.90
e	5.34	5.54
F	1.90	2.10
L	19.40	20.40
L2	4.03	4.23
Q	6.00	6.40
Q1	2.30	2.50
P	3.50	3.70

TO-3PB

单位 Unit: mm

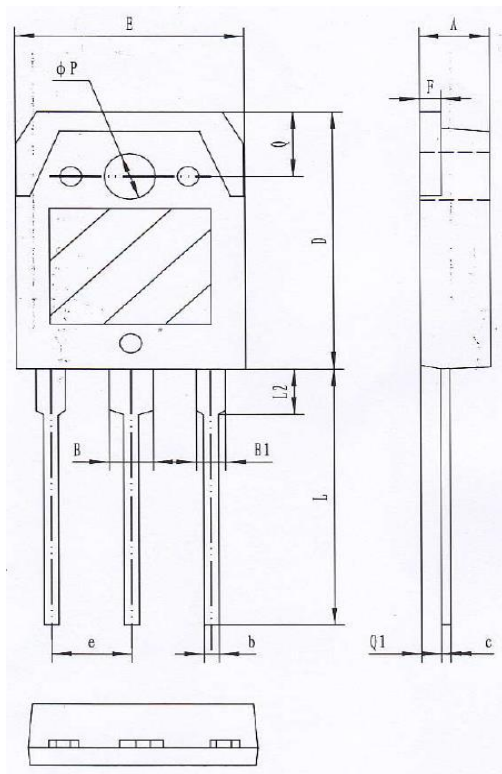

符号 symbol	MIN	MAX
A	4.60	5.00
B	2.90	3.20
B1	1.90	2.20
b	0.90	1.10
c	0.50	0.70
D	19.40	20.40
E	15.40	15.80
e	5.45(TYP)	
F	1.40	1.60
L	19.50	20.50
L2	3.30	3.70
Q	4.90	5.10
Q1	1.30	1.50
P	3.10	3.50





注意事项

- 1.吉林华微电子股份有限公司的产品销售分为直销和销售代理，无论哪种方式，订货时请与公司核实。
- 2.购买时请认清公司商标，如有疑问请与公司本部联系。
- 3.在电路设计时请不要超过器件的绝对最大额定值，否则会影响整机的可靠性。
- 4.本说明书如有版本变更不另外告知

NOTE

1. Jilin Sino-microelectronics co., Ltd sales its product either through direct sales or sales agent , thus, for customers, when ordering , please check with our company.
2. We strongly recommend customers check carefully on the trademark when buying our product, if there is any question, please don't be hesitate to contact us.
3. Please do not exceed the absolute maximum ratings of the device when circuit designing.
4. Jilin Sino-microelectronics co., Ltd reserves the right to make changes in this specification sheet and is subject to change without prior notice.

联系方式

吉林华微电子股份有限公司

公司地址：吉林省吉林市深圳街 99 号

邮编：132013

总机：86-432-64678411

传真：86-432-64665812

网址：www.hwdz.com.cn

市场营销部

地址：吉林省吉林市深圳街 99 号

邮编：132013

电话：86-432-64675588

64675688

64678411-3098/3099

传真：86-432-64671533

CONTACT

JILIN SINO-MICROELECTRONICS CO., LTD.

ADD: No.99 Shenzhen Street, Jilin City, Jilin Province, China.

Post Code: 132013

Tel: 86-432-64678411

Fax: 86-432-64665812

Web Site: www.hwdz.com.cn

MARKET DEPARTMENT

ADD: No.99 Shenzhen Street, Jilin City, Jilin Province, China.

Post Code: 132013

Tel: 86-432-64675588

64675688

64678411-3098/3099

Fax: 86-432-64671533

