



3FT4C/F/M/U/F1

主要参数 MAIN CHARACTERISTICS

| | |
|--------------|------|
| $I_{T(RMS)}$ | 4A |
| V_{DRM} | 800V |
| I_{GT} | 10mA |

用途

- 交流开关
- 相位控制

APPLICATIONS

- AC switching
- Phase control

产品特性

- 玻璃钝化芯片，高可靠性和一致性
- 低通态电流和高浪涌电流能力
- 环保 RoHS 产品

FEATURES

- Glass-passivated mesa chip for reliability and uniform
- Low on-state voltage and High I_{TSM}
- RoHS products

封装 Package

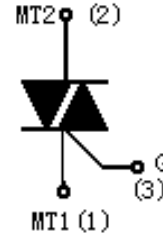

| 序号 Pin | 引线名称 Description |
|-----------|---------------------|
| 1 | 主电极 1 MT1 |
| 2 | 主电极 2 MT2 |
| 3 | 门极 G |

T0-220G

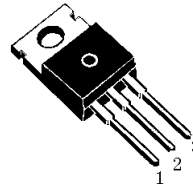

T0-220HF

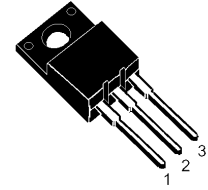

T0-126

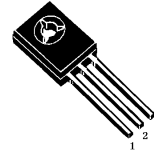

DKPAK

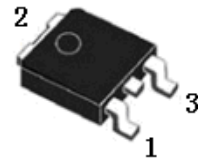

T0-220MF-K1

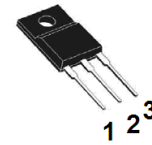



订货信息 ORDER MESSAGES

| 订货型号 Order codes | | | | 印记 Marking | 封装 Package |
|------------------|------------------------|------------------|------------------------|---------------|-----------------|
| 有卤-袋装 | 无卤-袋装 | 有卤-条管 | 无卤-条管 | 3FT4C | TO-220C |
| Halogen-Bag | Halogen-Fre e-Bag | Halogen-Tub e | Halogen-Fre e- Tube | | |
| 3FT4C-CA-C | 3FT4C-CA-C R | 3FT4C-CA-B | 3FT4C-CA-B R | | |
| 有卤-袋装 | 无卤-袋装 | 有卤-条管 | 无卤-条管 | 3FT4F | TO-220HF |
| Halogen-Bag | Halogen-Fre e-Bag | Halogen-Tub e | Halogen-Fre e- Tube | | |
| 3FT4F-FA-C | 3FT4F-FA-C R | 3FT4F-FA-B | 3FT4F-FA-B R | | |
| 有卤-编带 | 无卤-编带 | 有卤-袋装 | 无卤-袋装 | 3FT4U | DPAK |
| Halogen-Re el | Halogen-Fre e- Reel | Halogen-Bag | Halogen-Fre e-Bag | | |
| 3FT4U-R-A | 3FT4U-R-AR | N/A | N/A | | |
| 有卤-袋装 | 无卤-袋装 | 有卤-条管 | 无卤-条管 | 3FT4F1 | TO-220MF-K 1 |
| Halogen-Bag | Halogen-Fre e-Bag | Halogen-Tub e | Halogen-Fre e- Tube | | |
| 3FT4F1-F1- C | 3FT4F1-F1- CR | 3FT4F1-F1- B | 3FT4F1-F1- BR | | |
| 有卤-袋装 | 无卤-袋装 | 有卤-条管 | 无卤-条管 | 3FT4M | TO-126 |
| Halogen-Bag | Halogen-Fre e-Bag | Halogen-Tub e | Halogen-Fre e- Tube | | |
| 3FT4M-M-C | 3FT4M-M-C R | 3FT4M-M-B | 3FT4M-M-B R | | |

概述 GENERAL DESCRIPTION

3FT4C/F/M/U/F1是玻璃钝化芯片结构的四象限双向晶闸管。器件封装形式有TO-220C、TO-220HF、TO-126、DPAK和TO-220MF-K1。

3FT4C/F/M/U/F1 are Glass passivated four quadrant triacs. Available packages are TO-220C、TO-220HF、TO-126、DPAK and TO-220MF-K1.



绝对最大额定值 ABSOLUTE RATINGS ($T_C=25^\circ\text{C}$)

| 项 目 Parameter | 符 号 Symbol | 试 验 条 件 Condition | 数 值 Value | 单 位 Unit |
|--|---------------------|--|------------------------|------------------------|
| 重复峰值断态电压 Repetitive peak off-state voltage | V_{DRM} | | ± 600 ± 800 | V |
| 通态方均根电流 On-state RMS current | $I_{\text{T(RMS)}}$ | full sine wave | 4 | A |
| 非重复浪涌峰值通态电流 Non-repetitive surge peak on-state current | I_{TSM} | full sine wave , $t=20\text{ms}$ | 25 | A |
| | | full sine wave , $t=16.7\text{ms}$ | 27 | A |
| | | I^2t | $t=10\text{ms}$ | 3.1 |
| 通态电流临界上升率 Repetitive rate of rise of on-state current after triggering | di/dt | $I_{\text{TM}}=6\text{A}$, $I_{\text{G}}=0.2\text{A}$, $di_{\text{G}}/dt=0.2\text{A}/\mu\text{s}$ | 50 | $\text{A}/\mu\text{s}$ |
| 峰值门极电流 Peak gate current | I_{GM} | | 2 | A |
| 峰值门极电压 Peak gate voltage | V_{GM} | | 5 | V |
| 峰值门极功率 Peak gate power | P_{GM} | | 5 | W |
| 平均门极功率 Average gate power | $P_{\text{G(AV)}}$ | over any 20ms period | 0.5 | W |
| 存储温度 Storage temperature | T_{stg} | | -40~150 | $^\circ\text{C}$ |
| 操作结温 Operation junction temperature | T_{VJ} | | 125 | $^\circ\text{C}$ |



电特性 ELECTRICAL CHARACTERISTIC (T_C=25°C)

| 项 目 Parameter | 符 号 Symbol | 测 试 条 件 Condition | 最小 Min | 典型 Typ | 最大 Max | 单位 Unit | |
|--|------------------|---|--------------------|-----------|-----------|------------|----|
| 峰值重复断态电流 Peak Repetitive Blocking Current | I _{DRM} | V _{DM} =V _{DRM} , T _j =25°C, gate open | - | - | 10 | μ A | |
| | | V _{DM} =V _{DRM} , T _j =125°C, gate open | - | - | 0.5 | mA | |
| 峰值通态电压 Peak on-state voltage | V _{TM} | I _{TM} =5A | - | - | 1.7 | V | |
| 门极触发电流 Gate trigger current | I _{GT} | V _{DM} =12V, R _L =100 Ω | MT1(-),MT2(+),G(+) | - | - | 10 | mA |
| | | | MT1(-),MT2(+),G(-) | - | - | 10 | mA |
| | | | MT1(+),MT2(-),G(-) | - | - | 10 | mA |
| | | | MT1(+),MT2(-),G(+) | - | - | 25 | mA |
| 门极触发电压 Gate trigger voltage | V _{GT} | V _{DM} =12V, R _L =100 Ω | MT1(-),MT2(+),G(+) | - | - | 1.5 | V |
| | | | MT1(-),MT2(+),G(-) | - | - | 1.5 | V |
| | | | MT1(+),MT2(-),G(-) | - | - | 1.5 | V |
| | | | MT1(+),MT2(-),G(+) | - | - | 2.0 | V |
| 维持电流 Holding current | I _H | V _{DM} =12V, I _{GT} =0.1A | - | - | 15 | mA | |
| 擎住电流 Latching current | I _L | V _{DM} =12V, I _{GT} =0.1A | - | - | 30 | mA | |
| 断态临界电压上升率 Rise of off- state voltage | dV/dt | V _{DM} =67% V _{DRM(MAX)} , T _j =125°C, gate open | - | 50 | - | V/μ s | |
| 门极开通时间 Gate controlled turn-on time | tgt | I _{TM} =6A, V _{DM} =V _{DRM(MAX)} , I _G =0.1A, dI _G /dt=5A/μ S | - | 2 | - | μ s | |

热特性 THERMAL CHARACTERISTIC

| 项 目 Parameter | 符 号 Symbol | 条 件 Condition | 最小 Min | 典型 Typ | 最大 Max | 单位 Unit |
|--|----------------------|-----------------------------------|-----------|-----------|-----------|------------|
| 结到管壳的热阻 Thermal resistance junction to case | R _{th(j-c)} | full cycle(TO-220C/TO-126/TO-252) | | | 3.0 | °C/W |
| | | full cycle(TO-220HF/TO-220MF-K1) | | | 5.5 | °C/W |

电绝缘特性 ELECTRICAL ISOLATION

| 项 目 Parameter | 符 号 Symbol | 条 件 Condition | 数 值 Value | 单 位 Unit |
|---------------------------|-------------------|---|--------------|-------------|
| 绝缘电压 Isolation voltage | V _{ISOL} | 1 minute, leads to mounting tab TO-220HF/TO-220MF-K1 | 2000 | V |





特征曲线 ELECTRICAL CHARACTERISTICS (curves)

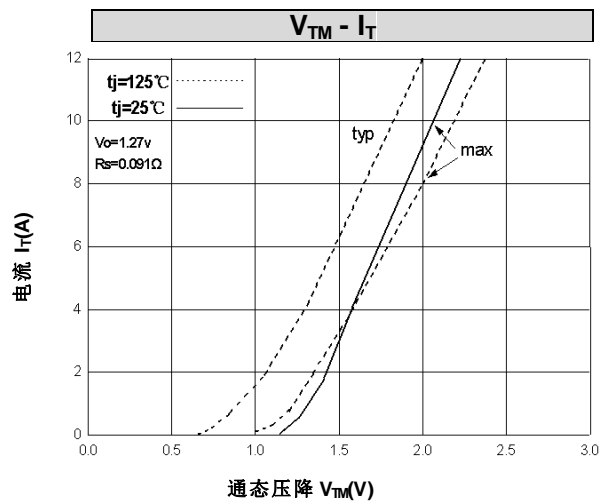
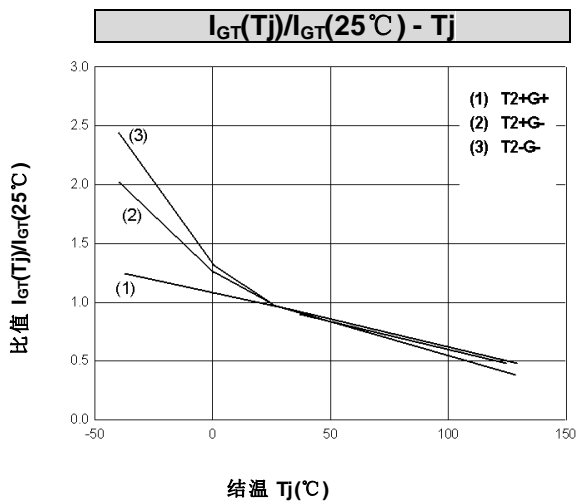
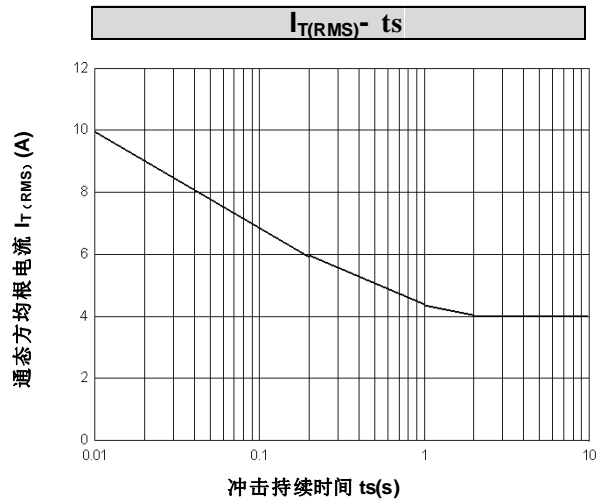
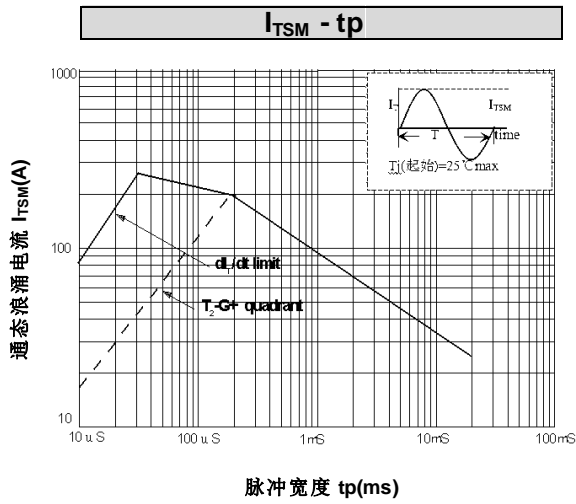
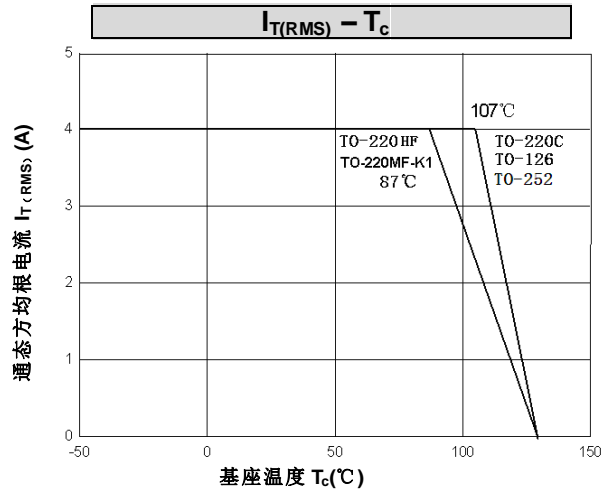
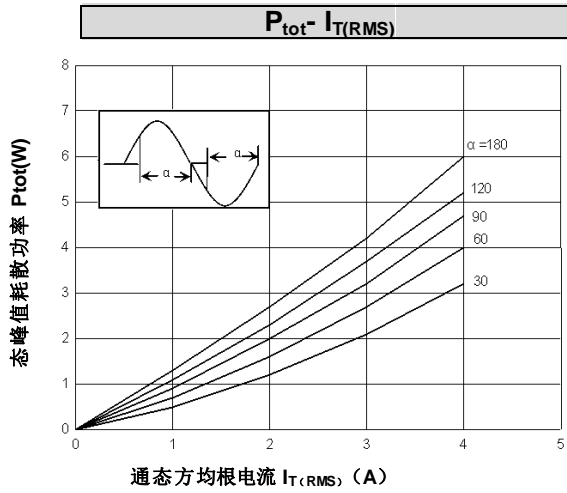



外形尺寸 PACKAGE MECHANICAL DATA

TO-220C

单位 Unit : mm

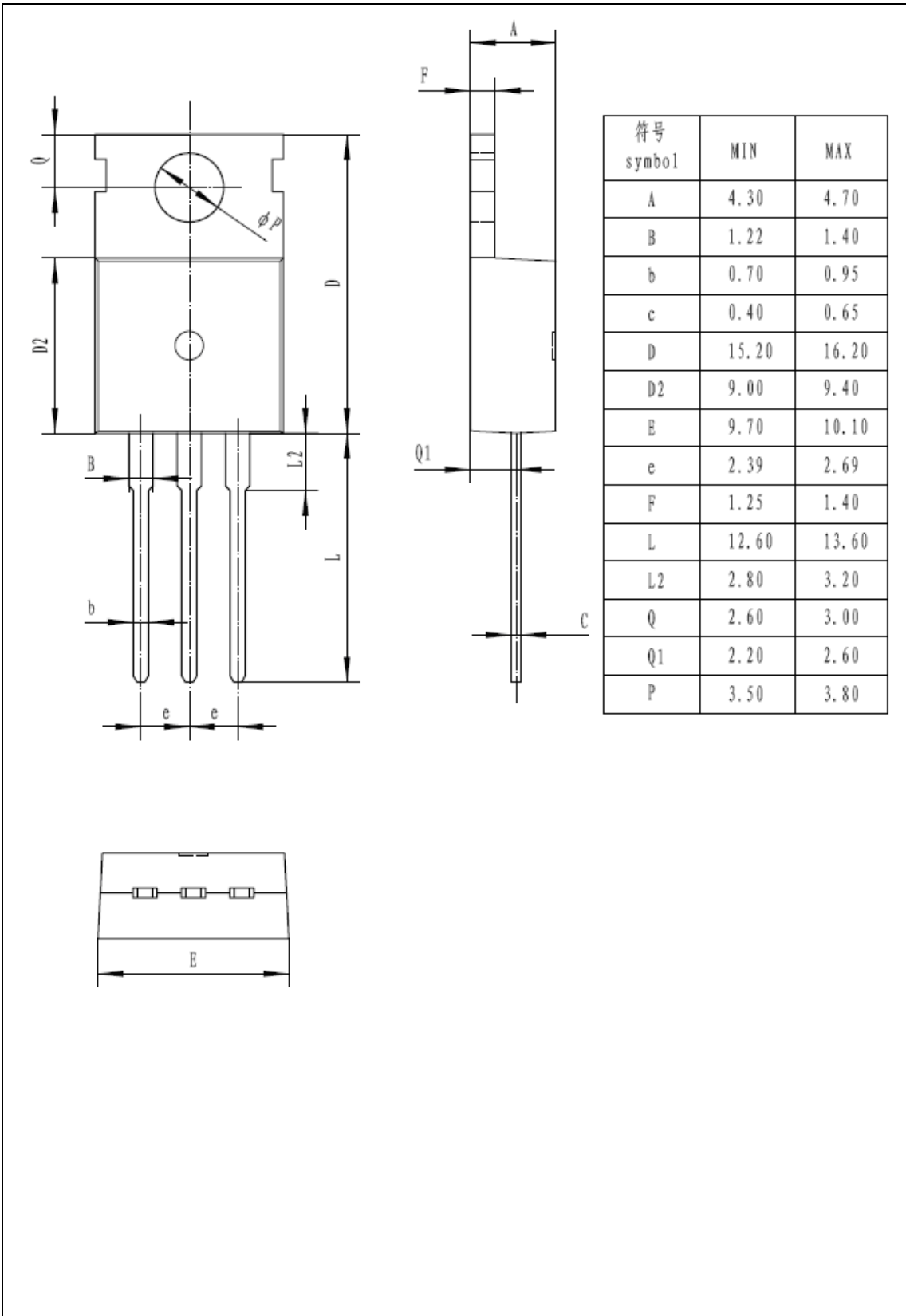



外形尺寸 PACKAGE MECHANICAL DATA

TO-220HF

单位 Unit : mm

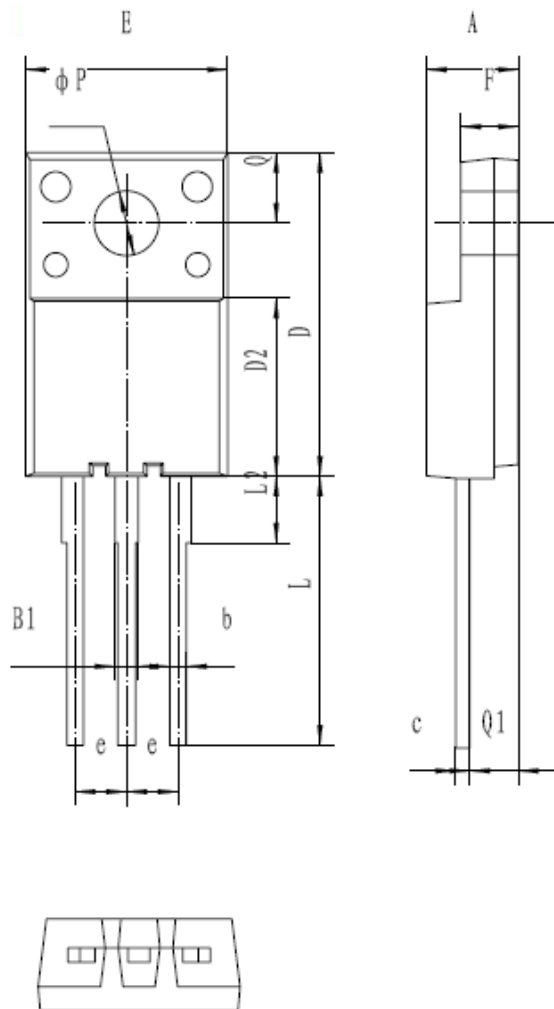

| 符号 symbol | MIN | MAX |
|--------------|----------|-------|
| A | 4.0 | 5.0 |
| B1 | 0.87 | 1.27 |
| b | 0.72 | 0.92 |
| c | 0.5 | 0.7 |
| D | 15.0 | 16.5 |
| D2 | 7.8 | 9.4 |
| E | 9.62 | 10.62 |
| e | 2.54 TYP | |
| F | 2.3 | 3.3 |
| L | 13.0 | 14.0 |
| L2 | 3.1 | 3.5 |
| ϕP | 3.0 | 3.4 |
| Q | 3.15 | 3.55 |
| Q1 | 2.2 | 2.5 |





外形尺寸 PACKAGE MECHANICAL DATA

TO-126

单位 Unit : mm

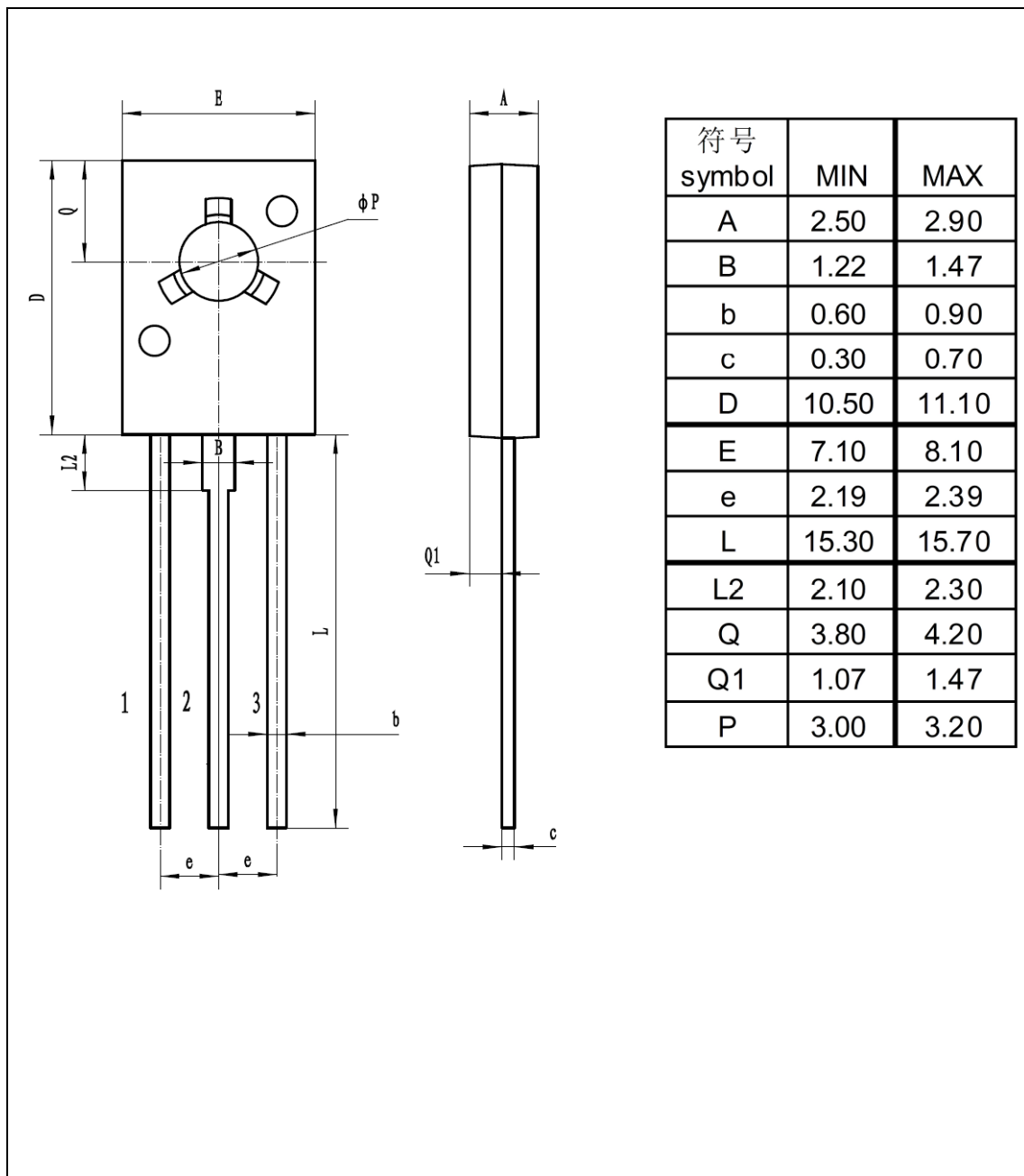



外形尺寸 PACKAGE MECHANICAL DATA

DPAK

单位 Unit : mm

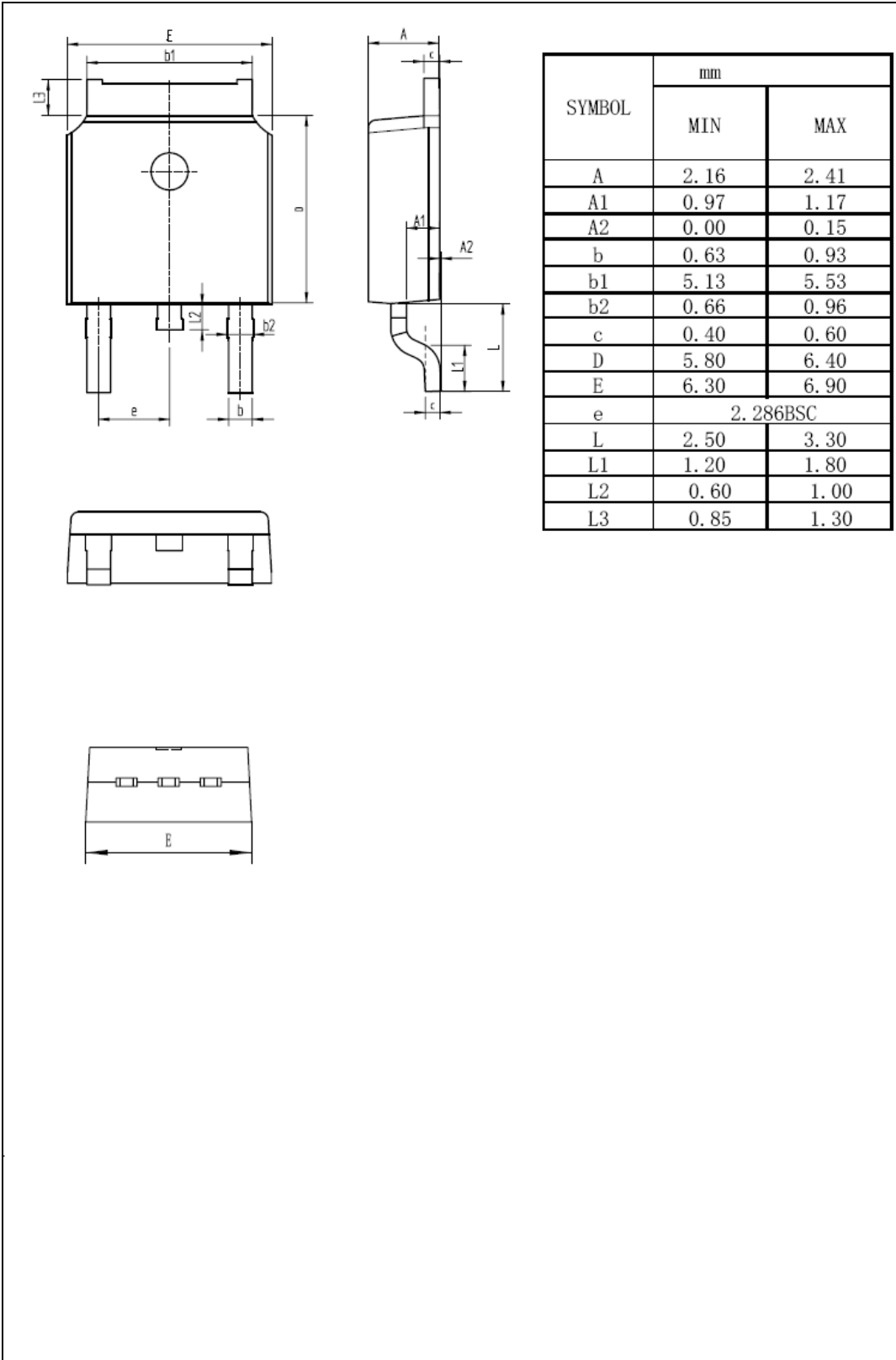



外形尺寸 PACKAGE MECHANICAL DATA

TO-220MF-K1

单位 Unit : mm

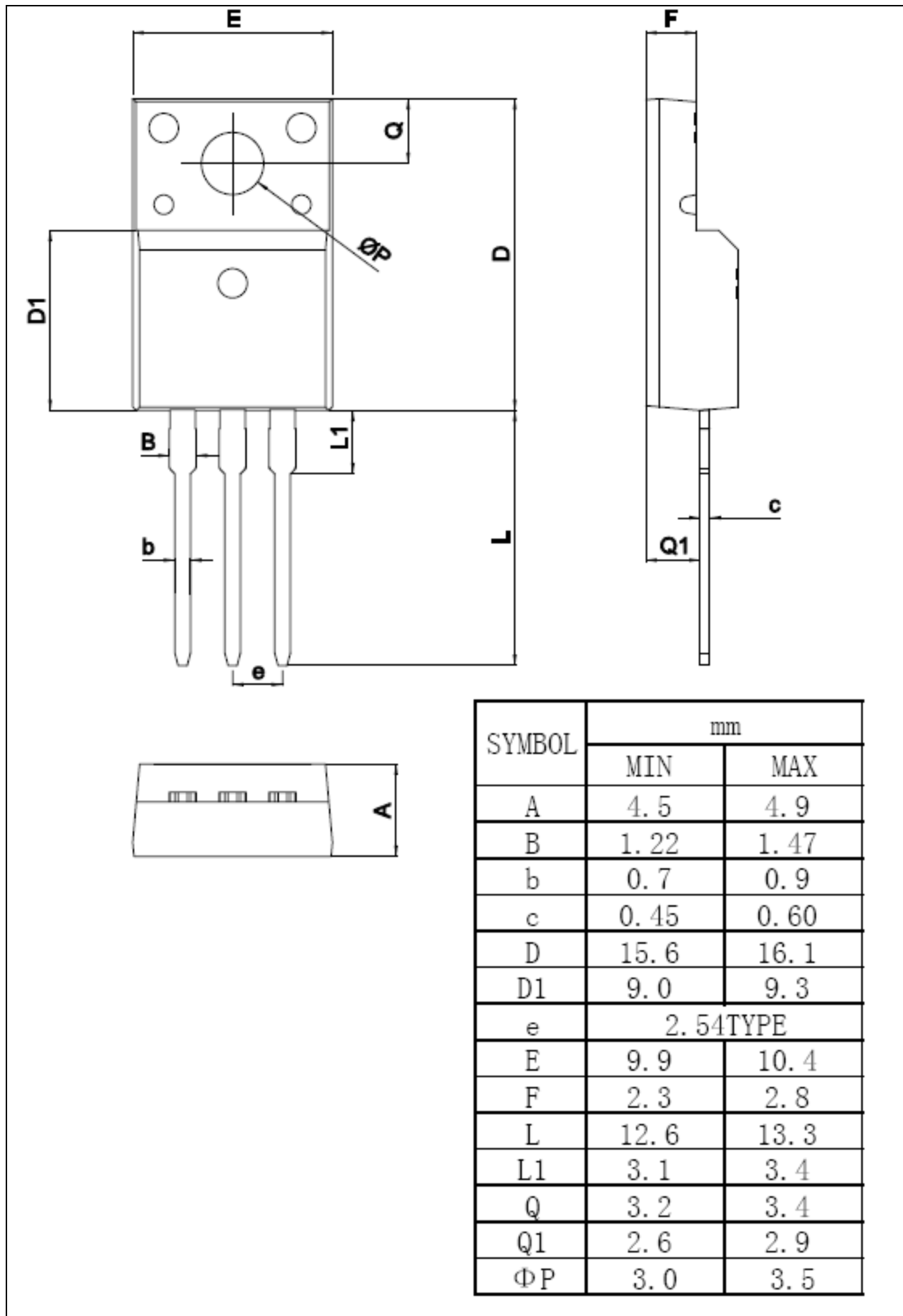



注意事项

1. 吉林华微电子股份有限公司的产品销售分为直销和销售代理，无论哪种方式，订货时请与公司核实。
2. 购买时请认清公司商标，如有疑问请与公司本部联系。
3. 在电路设计时请不要超过器件的绝对最大额定值，否则会影响整机的可靠性。
4. 本说明书如有版本变更不另外告知

NOTE

1. Jilin Sino-microelectronics co., Ltd sales its product either through direct sales or sales agent , thus, for customers, when ordering, please check with our company.
2. We strongly recommend customers check carefully on the trademark when buying our product, if there is any question, please don't be hesitate to contact us.
3. Please do not exceed the absolute maximum ratings of the device when circuit designing.
4. Jilin Sino-microelectronics co., Ltd reserves the right to make changes in this specification sheet and is subject to change without prior notice.

联系方式

吉林华微电子股份有限公司

公司地址：吉林省吉林市深圳街 99 号

邮编：132013

总机：86-432-64678411

传真：86-432-64665812

网址：www.hwdz.com.cn

销售业务部

地址：吉林省吉林市深圳街 99 号

邮编：132013

电话：86-432-64675588

64675688

64678411

传真：86-432-64671533

CONTACT

JILIN SINO-MICROELECTRONICS CO., LTD.

ADD: No.99 Shenzhen Street, Jilin City,
Jilin Province, China.

Post Code: 132013

Tel: 86-432-64678411

Fax: 86-432-64665812

Web Site: www.hwdz.com.cn

MARKET DEPARTMENT

ADD: No.99 Shenzhen Street, Jilin City,
Jilin Province, China.

Post Code: 132013

Tel: 86-432-64675588

64675688

64678411

Fax: 86-432-64671533

