



2SA970 (PNP)

用途

- 低噪音音频放大器

产品特性

- 高集电极电压: $V_{CE0}=-120V$ (min)
- 与 2SC2240 互补
- 高直流增益
- 环保 (RoHS) 产品

APPLICATIONS

- Low noise audio amplifier applications

FEATURES

- High collector voltage: $V_{CE0}=-120V$ (min)
- Complementary 2SC2240
- High DC current gain
- RoHS Devices

封装 Package

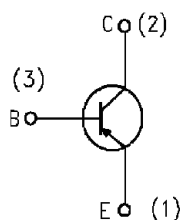

TO-92

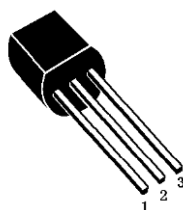

1. 发射极 EMITTER
2. 集电极 (热沉)
COLLECTOR (HEAT SINK)
3. 基极 BASE

订货信息 ORDER MESSAGE

订货型号 Order codes						印 记 Markin g	封 装 Package
有卤-条管 Halogen-T ube	无卤-条管 Halogen Free-Tube	有卤-袋装 Halogen- Reel	无卤-袋装 Halogen Free-Reel	有卤-编带 Halogen- Reel	无卤-编带 Halogen Free-Reel		
N/A	N/A	2SA970-T J-C	N/A	N/A	N/A	A970	TO-92



2SA970(PNP)

绝对最大额定值 **ABSOLUTE RATINGS** ($T_c=25^\circ\text{C}$ unless otherwise noted)

项 目 Parameter	符 号 Symbol	数 值 Value	单 位 Unit
集电极—基极直流电压 Collector- Base Voltage	V_{CBO}	-120	V
集电极—发射极直流电压 Collector- Emitter Voltage	V_{CEO}	-120	V
发射极—基极直流电压 Emitter-Base Voltage	V_{EBO}	-5.0	V
最大集电极电流 Collector Current	I_C	-50	mA
最大基极电流 Base Current	I_B	-10	mA
耗散功率 Total Power Dissipation($T_c=25^\circ\text{C}$)	P_D	0.5	W
最高结温 Junction Temperature	T_j	150	$^\circ\text{C}$
贮存温度 Storage Temperature	T_{stg}	-55~150	$^\circ\text{C}$

电特性 ELECTRICAL CHARACTERISTIC

项 目 Parameter	测试条件 Tests conditions	最小值 Value(min)	典型值 Value(typ)	最大值 Value(max)	单 位 Unit
$V_{(BR)CEO}$	$I_C=-1\text{mA}, I_B=0$	-120	-	-	V
I_{CBO}	$V_{CB}=-120\text{V}, I_E=0$	-	-	-0.1	μA
I_{EBO}	$V_{EB}=-5\text{V}, I_C=0$	-	-	-0.1	μA
hFE	$V_{CE}=-6\text{V}, I_C=-2\text{mA}$	200	-	700	-
$V_{CE(sat)}$	$I_C=-10\text{mA}, I_B=-1\text{mA}$	-	-	-0.3	V
$V_{BE(ON)}$	$V_{CE}=-6\text{V}, I_C=-2\text{mA}$	-	-	-1.0	V
fT	$V_{CE}=-6\text{V}, I_C=-1\text{mA}$	-	100	-	MHz
C_{ob}	$V_{CE}=-10\text{V}, I_E=0, f=1.0\text{MHz}$	-	3.0	-	pF

hFE Classification

Classification	A	B
hFE	200-400	350-700

热特性 THERMAL CHARACTERISTIC

项 目 Parameter	符 号 Symbol	最小值 Value(min)	最大值 Value(max)	单 位 Unit
结到环境的热阻 TO-92 Thermal Resistance Junction Ambient TO-92	$R_{th(j-a)}$	-	250	$^\circ\text{C/W}$



2SA970(PNP)

特征曲线 ELECTRICAL CHARACTERISTICS (curves)

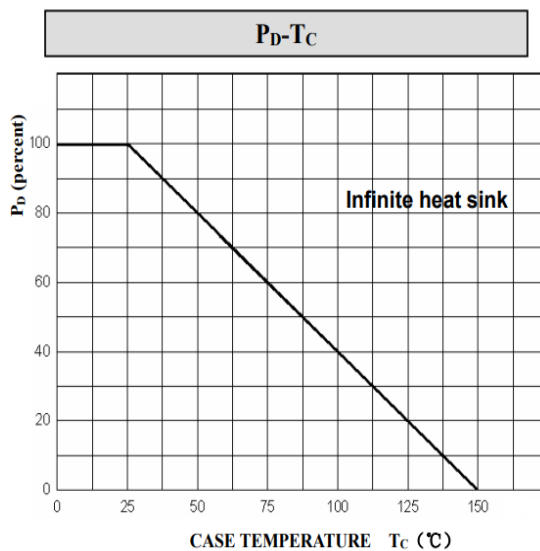
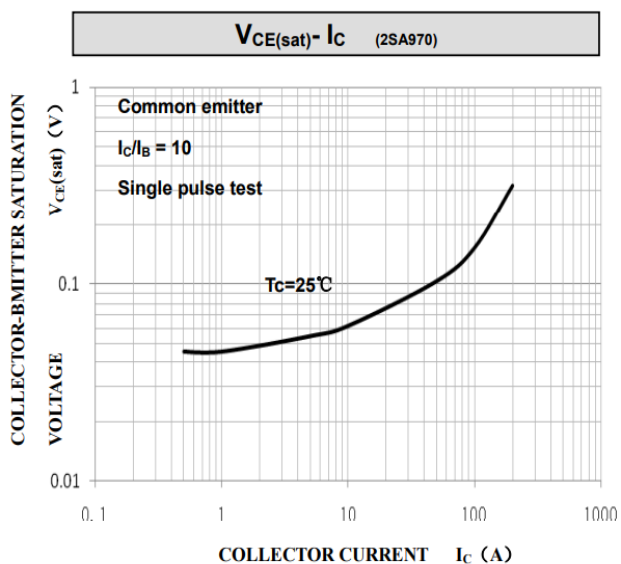
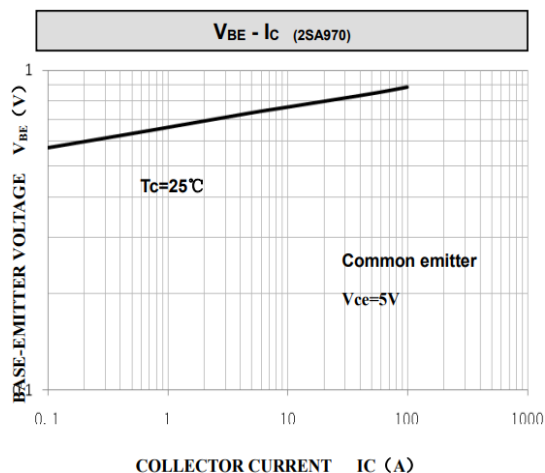
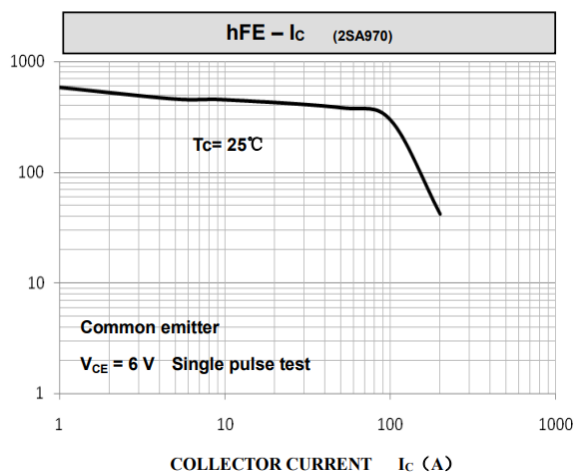



外形尺寸 PACKAGE MECHANICAL DATA

TO-92

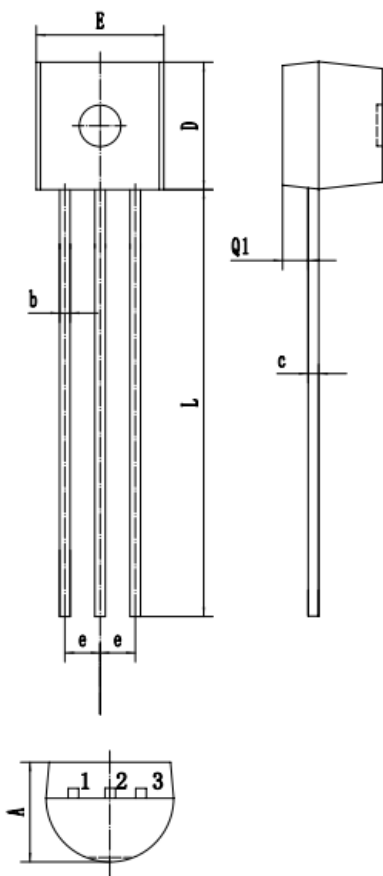

符号 symbol	MIN	MAX
A	3.30	3.90
b	0.35	0.55
c	0.31	0.51
D	4.30	4.90
E	4.30	4.90
e	1.17	1.37
L	12.50	15.50
Q1	0.85	1.00



注意事项

1. 吉林华微电子股份有限公司的产品销售分为直销和销售代理，无论哪种方式，订货时请与公司核实。
2. 购买时请认清公司商标，如有疑问请与公司本部联系。
3. 在电路设计时请不要超过器件的绝对最大额定值，否则会影响整机的可靠性。
4. 本说明书如有版本变更不另外告知。

NOTE

1. Jilin Sino-microelectronics co., Ltd sales its product either through direct sales or sales agent , thus, for customers, when ordering , please check with our company.
2. We strongly recommend customers check carefully on the trademark when buying our product, if there is any question, please don't be hesitate to contact us.
3. Please do not exceed the absolute maximum ratings of the device when circuit designing.
4. Jilin Sino-microelectronics co., Ltd reserves the right to make changes in this. specification sheet and is subject to change without prior notice.

联系方式

吉林华微电子股份有限公司

公司地址：吉林省吉林市深圳街 99 号

邮编：132013

总机：86-432-64678411

传真：86-432-64665812

网址：www.hwdz.com.cn

CONTACT

JILIN SINO-MICROELECTRONICS CO., LTD.

ADD: No.99 Shenzhen Street, Jilin City, Jilin Province, China.

Post Code: 132013

Tel: 86-432-64678411

Fax: 86-432-64665812

Web Site: www.hwdz.com.cn